

3 elements yagi antenna,
fibreglass covered radiator.
Lightning protection.

MAIN CHARACTERISTICS

Type	: 3 el. Yagi
Frequency range	: 435 - 470 MHz
Input impedance	: 50 ohm
V.S.W.R.	: < 1:1.5
Beamwidth -3 dB	: H plane 68° - E plane 140°
Maximum rated RF power	: 200 watt
Polarization	: Vertical or Horizontal
Gain	: 5.5 dBd
Type of connection	: N female
Mounting hole	: From 30 to 62 mm master tube
Boom material	: Anodized Aluminium
Elements material	: Anodized Aluminium
Wind resistance	: 120 Km/h.
Dimensions	: 630 mm x 410 mm
Net weight	: 2000 g

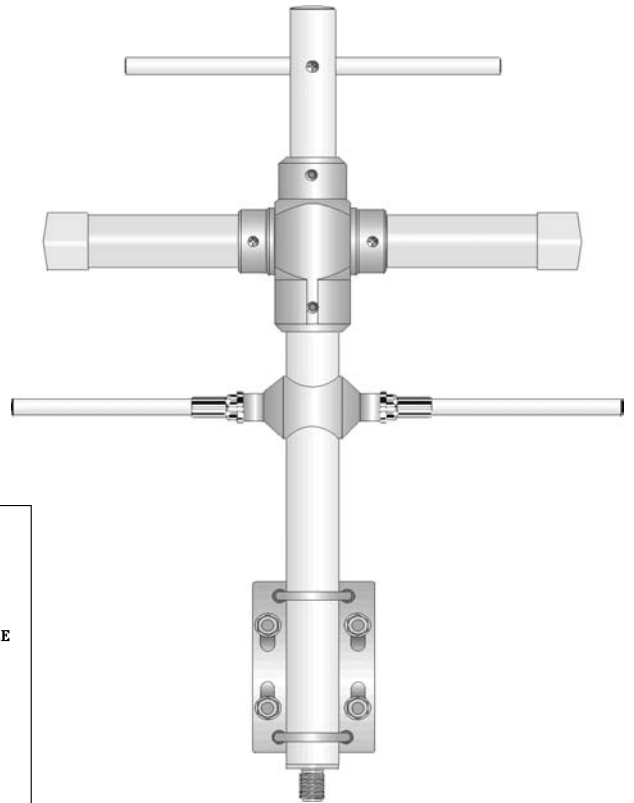

HORIZONTAL PATTERN

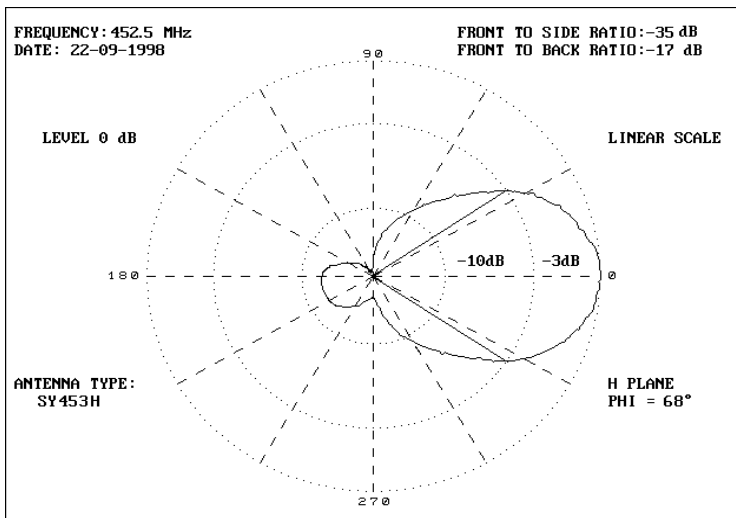

VERTICAL PATTERN

